

# Thermoplastic outlet box installation box

2505110





## General information

Item number	2505110
Model	Thermoplastic outlet box
Colour	white

## Electrical parameters

Voltage	400V
Poles	5P

## Standards/Directives

According to	VDE 0606
Standard	installation box
Certification marks	 

## Operating conditions

Storage temperature	-25°C to +70°C
Operating temperature	-25°C to +40°C
Relative humidity	5 to 95%, no condensation
Degree of protection	IP20

## Materials

Contact Carrier	PA
Housing	PS

### Connecting cable

Cross section	5x2,5mm <sup>2</sup> -6mm <sup>2</sup>
Cable diameter, dimension a	9,5-12,5mm
Insulation strip length sheath, dimension b	-
Trim L/N, dimension c	-
Insulation strip length cores, dimension d	8-10mm

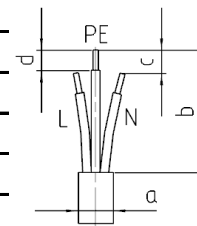

### Connection screws

Max. torque for screws L-N/PE	1,2 Nm
Screw drive L-N/PE	Combined slot/PZ2
Max. torque for screws strain relief	0,5 Nm
Screw drive strain relief	Combined slot/PZ1

### Additional technical information

Note	If conductor section is > 5x2,5mm <sup>2</sup> use additional strain relief
------	---

Subject to modifications

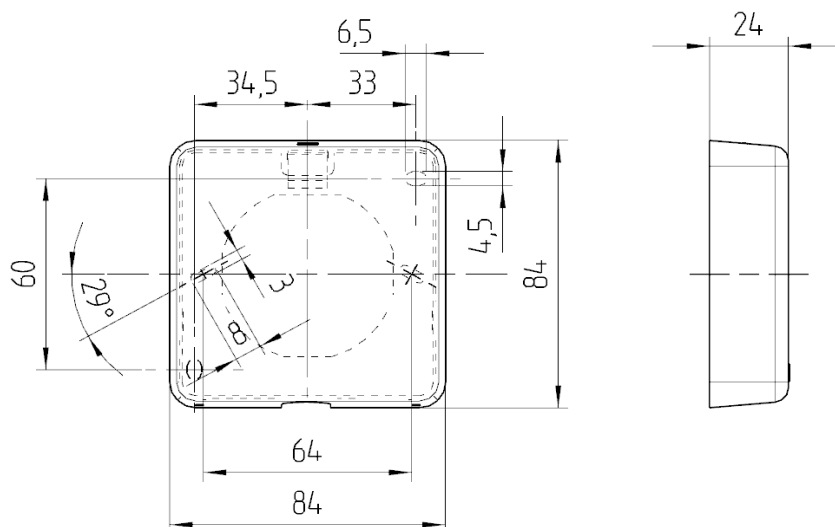

If the application requires extended specifications, we recommend to test the application under real or simulated conditions. Parameters like duration, quantity and temperature will effect the result significantly